

Scenarios to compare market design options

Sophie Dourlens-Quaranta, TECHNOFI (Market4RES WP4 leader)



Introduction

- To compare the impacts of different market design options in a robust manner, scenarios have to be chosen
 - Support to sensitivity analyses with different features of the electric system
- Three scenarios are proposed
 - A **reference scenario** mimicking the current situation (2013-2014)
 - A **standard 2020 scenario** corresponding to the official publications regarding the expected situation at 2020
 - A **more ambitious scenario at 2020** in terms of RES penetration (RES+ scenario)





Outline

- Description of the three proposed scenarios
 - Summary of main features of each scenario (qualitative)
 - Common hypotheses to all scenarios
 - Description of the three scenarios (quantitative)
- Combining the design options with the selected scenarios
- Proposed parameters of the studied options





Outline

- Description of the three proposed scenarios
 - **Summary of main features of each scenario (qualitative)**
 - Common hypotheses to all scenarios
 - Description of the three scenarios (quantitative)
- Combining the design options with the selected scenarios
- Proposed parameters of the studied options



Summary of the main features of each scenario (qualitative)

Scenario name	Thermal generation			RES generation	Demand	Transmission network
	Installed capacities	Flexibility	Economic parameters			
2013 scenario (reference scenario)						
2020 standard scenario						
2020 RES+ scenario						

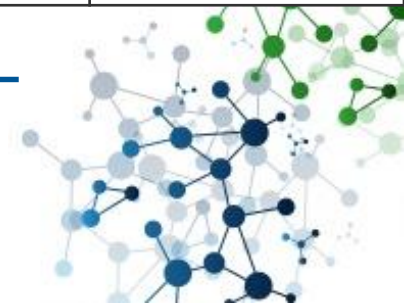

Summary of the main features of each scenario (qualitative)

Scenario name	Thermal generation			RES generation	Demand	Transmission network
	Installed capacities	Flexibility	Economic parameters			
2013 scenario (reference scenario)	Current installed capacities	Current flexibility level	Current CO ₂ price and fuel costs	Current installed capacities	Current level of peak demand	Current cross-border capacities
2020 standard scenario						
2020 RES+ scenario						

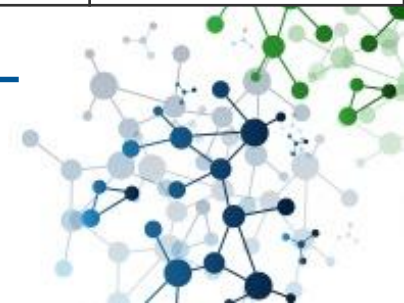

Summary of the main features of each scenario (qualitative)

Scenario name	Thermal generation			RES generation	Demand	Transmission network
	Installed capacities	Flexibility	Economic parameters			
2013 scenario (reference scenario)	Current installed capacities	Current flexibility level	Current CO ₂ price and fuel costs	Current installed capacities	Current level of peak demand	Current cross-border capacities
2020 standard scenario	Installed capacities at 2020 as foreseen today	Current flexibility level	Foreseen values at 2020	2020 RES objectives	Level of peak demand at 2020 as foreseen today	2020 cross-border capacities as foreseen today
2020 RES+ scenario						

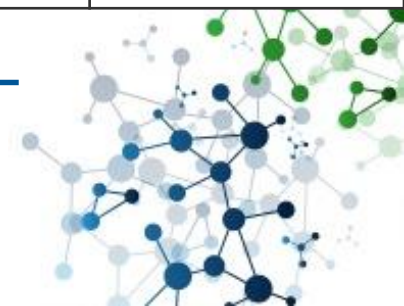

Summary of the main features of each scenario (qualitative)

Scenario name	Thermal generation			RES generation	Demand	Transmission network
	Installed capacities	Flexibility	Economic parameters			
2013 scenario (reference scenario)	Current installed capacities	Current flexibility level	Current CO ₂ price and fuel costs	Current installed capacities	Current level of peak demand	Current cross-border capacities
2020 standard scenario	Installed capacities at 2020 as foreseen today	Current flexibility level	Foreseen values at 2020	2020 RES objectives	Level of peak demand at 2020 as foreseen today	2020 cross-border capacities as foreseen today
2020 RES+ scenario	Significant decrease in thermal installed capacities	Higher flexibility of thermal units	Higher CO₂ price (impact on merit order curve)	Additional RES capacities	Level of peak demand at 2020 as foreseen today	2020 cross-border capacities as foreseen today

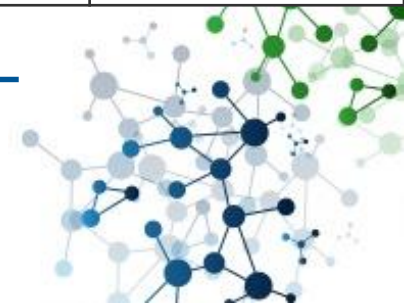



Outline

- Description of the three proposed scenarios
 - Summary of main features of each scenario (qualitative)
 - **Common hypotheses to all scenarios**
 - Description of the three scenarios (quantitative)
- Combining the design options with the selected scenarios
- Proposed parameters of the studied options



Common hypotheses to all scenarios

- Geographic scope

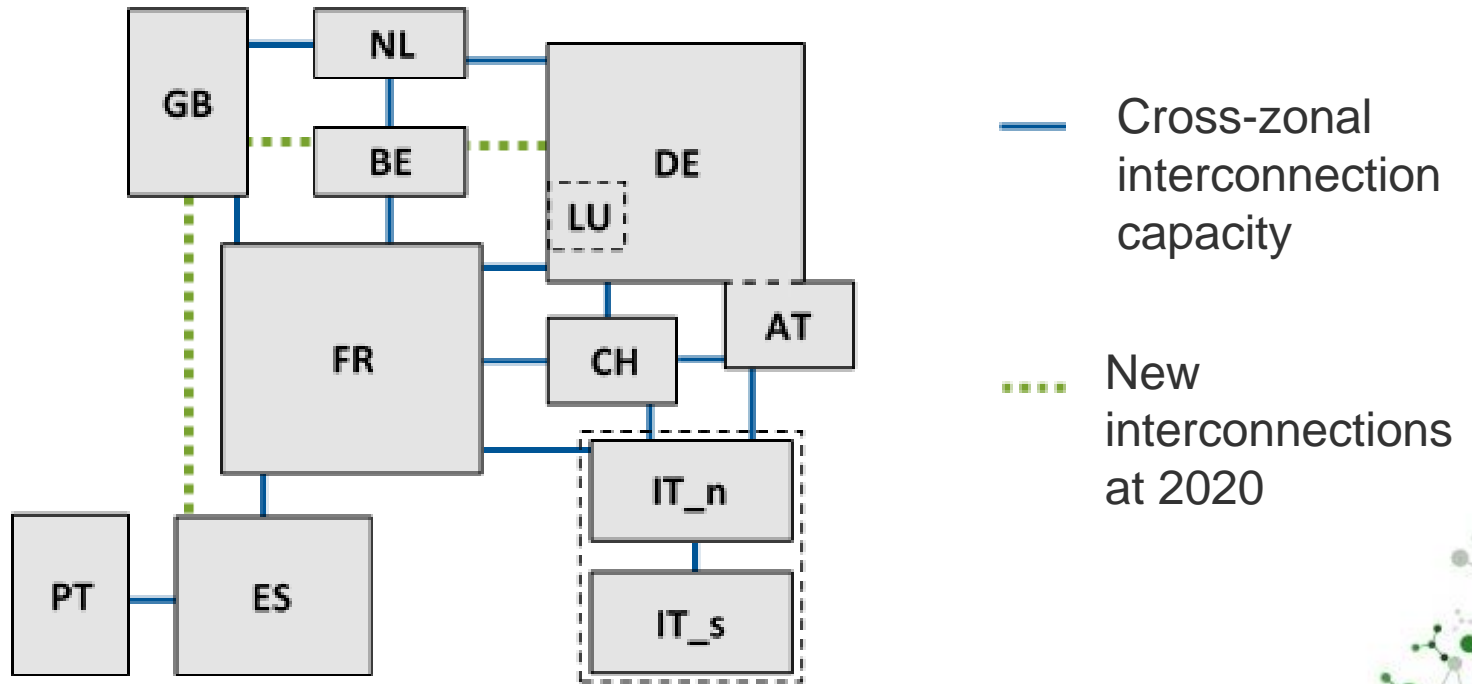



Common hypotheses to all scenarios

- Simulation period
 - Detailed simulations will be run over a few months covering different seasons
 - 6 months from February to July are considered





Common hypotheses to all scenarios

- **Modelling of thermal generation capacities**

- 23 different types of thermal generation units are considered: 5 for nuclear, 6 for coal, 10 for gas, 2 for oil
- Different technical features (nominal capacity, start-up duration, gradient, variable cost...) mimicking the features of actual generation units

→ Actual installed capacities are distributed amongst these different types according to the expertise embedded in OPTIMATE





Outline

- Description of the three proposed scenarios
 - Summary of main features of each scenario (qualitative)
 - Common hypotheses to all scenarios
 - **Description of the three scenarios (quantitative)**
- Combining the design options with the selected scenarios
- Proposed parameters of the studied options



Description of the three scenarios (quantitative)

- Peak load (MW):
 - ENTSO-E SO&AF values as references
 - Increased by 10% to compensate their “under normal climatic conditions” nature

	AT	BE	FR	DE	GB	IT	NL	PT	ES	CH	Total (GW)
2013 scenario	11,770	14,806	91,630	97,581	51,290	56,419	18,051	8,723	42,251	10,780	403

Description of the three scenarios (quantitative)

- Peak load (MW):
 - ENTSO-E SO&AF values as references
 - Increased by 10% to compensate their “under normal climatic conditions” feature

	AT	BE	FR	DE	GB	IT	NL	PT	ES	CH	Total (GW)
2013 scenario	11,770	14,806	91,630	97,581	51,290	56,419	18,051	8,723	42,251	10,780	403
2020 (standard & RES+)	13,090	15,609	94,820	97,647	53,647	64,328	19,437	9,207	47,399	12,100	427

Description of the three scenarios (quantitative)

- Renewable installed capacities **2013**
 - Wind & PV: EWEA and EPIA figures
 - Hydro dams, run of river, CHPs: figures provided by OPTIMATE, updated with ENTSO-E

Energy source	AT	BE	FR	DE	GB	IT	NL	PT	ES	CH	Total (GW)
Hydro											
Dams	8,000	1,310	17,800	6,700	2,740	15,000	0	3,020	12,000	10,500	77
Run of river	5,427	120	7,634	5,214	1,229	7,009	38	2,632	7,382	3,305	40
Wind	1,684	1,651	8,254	33,730	10,531	8,551	2,693	4,724	22,959	60	95
PV	613	2,983	4,673	35,715	3,375	17,928	665	278	5,340	737	72
Thermal must-run (CHP, ...)	4,229	2,750	3,731	7,871	682	15,639	3,927	2,000	14,608	355	56

Description of the three scenarios (quantitative)

- Renewable installed capacities **2020 standard**
 - Wind, solar (PV+CSP), biomass: figures from NREAPs (possibly updated by EWEA and EPIA)
 - Hydro: no significant change compared to 2013

Energy source	AT	BE	FR	DE	GB	IT	NL	PT	ES	CH	Total (GW)	Comp / 2013
Wind												
Onshore	3,400	3,000	18,500	45,000	11,500	12,000	4,000	5,700	26,000	1,200	130	159%
Offshore	-	1,500	1,500	6,500	9,500	-	1,400	25	5	-	20	
Solar												
PV	2,013	3,903	10,273	53,215	10,029	24,428	2,615	688	7,140	2,407	117	161%
CSP	-	-	540	-	-	600	-	500	5,079	-	7	-
Thermal must-run (CHP, biomass ...)	4,229	3,120	4,230	9,160	1,972	17,598	4,017	2,100	14,758	355	62	110%

Description of the three scenarios (quantitative)

- Renewable installed capacities **2020 RES+**
 - Wind, solar (PV+CSP), biomass: double the spread between 2013 and 2020 standard scenarios

Energy source	AT	BE	FR	DE	GB	IT	NL	PT	ES	CH	Total (GW)	Comp / 2020 standard
Wind												
Onshore	5,116	4,349	28,746	56,270	12,469	15,449	5,307	6,676	29,041	2,340	166	127%
Offshore	-	3,000	3,000	13,000	19,000	-	2,800	50	10	-	41	200%
Solar												
PV	3,413	4,823	15,873	70,715	16,683	30,928	4,565	1,098	8,940	4,077	161	138%
Solar thermal	-	-	1,080	-	-	1,200	-	1,000	10,158	-	13	200%
Thermal must-run (CHP, biomass...)	4,229	3,490	4,729	10,449	3,262	19,557	4,107	2,200	14,908	355	67	109%

Description of the three scenarios (quantitative)

- Solar profiles 2020
 - PV profiles embedded with OPTIMATE
 - Need to change these profiles to take account of CSP development

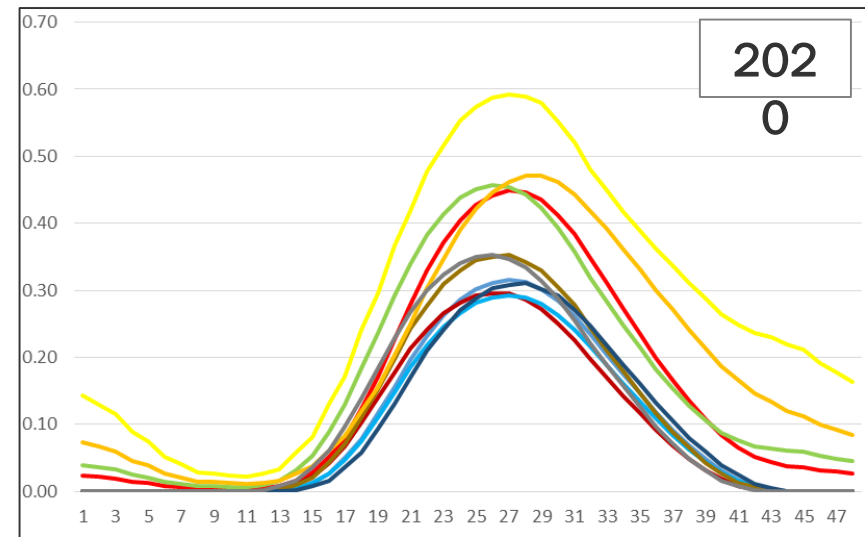
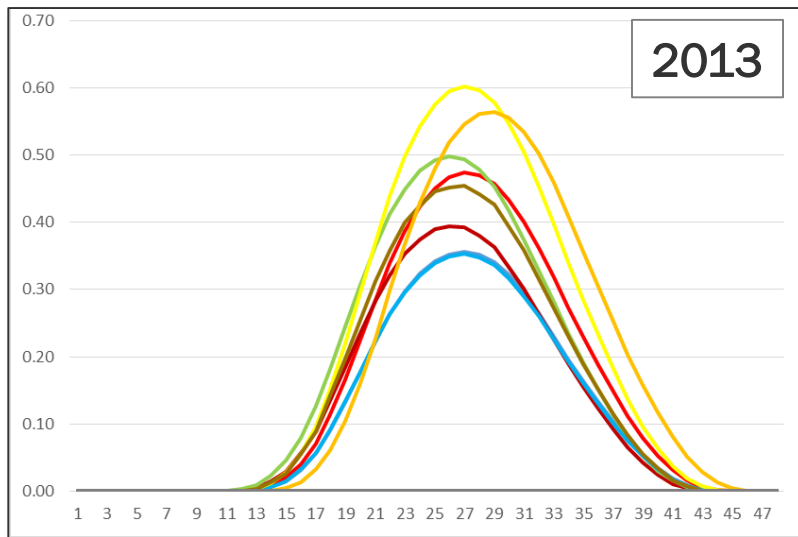

19 — BE — FR — DE — IT — NL — ES — CH — PT — GB — AT

Description of the three scenarios (quantitative)

- Thermal installed capacities **2013**
 - Source: ENTSO-E SO&AF figures

Energy source	AT	BE	FR	DE	GB	IT	NL	PT	ES	CH	Total (GW)
Nuclear	0	5,930	63,100	12,070	8,980	0	490	0	7,580	3,200	101
Coal	1,585	410	10,500	51,240	18,600	18,930	6,690	1,760	11,080	0	121
Gas	5,119	6,880	5,800	28,960	29,880	41,640	20,060	3,830	31,750	100	174
Oil	360	210	6,700	3,450	2,290	6,860	0	0	0	0	20

Description of the three scenarios (quantitative)

- Thermal installed capacities **2020 standard**
 - Source: ENTSO-E SO&AF figures

Energy source	AT	BE	FR	DE	GB	IT	NL	PT	ES	CH	Total (GW)	Comp / 2013
Nuclear	0	5,060	63,100	8,110	8,980	0	490	0	7,580	2,800	96	95%
Coal	1,700	0	8,200	44,010	15,560	18,010	5,590	580	9,930	0	104	86%
Gas	7,800	7,920	7,500	27,910	30,530	42,870	20,020	5,590	31,980	100	182	105%
Oil	100	0	2,900	2,410	990	6,610	0	0	0	0	13	65%

Description of the three scenarios (quantitative)

- Thermal installed capacities **2020 RES+**
 - Double the spread between 2013 and 2020 standard scenarios

Energy source	AT	BE	FR	DE	GB	IT	NL	PT	ES	CH	Total (GW)	Comp / 2020 standard
Nuclear	0	4,190	63,100	4,150	8,980	0	490	0	7,580	2,400	91	95%
Coal	1,815	0	5,900	36,780	12,520	17,090	4,490	0	8,780	0	87	84%
Gas	10,481	8,960	9,200	26,860	31,180	44,100	19,980	7,350	32,210	100	190	105%
Oil	0	0	0	1,370	0	6,360	0	0	0	0	8	59%

Description of the three scenarios (quantitative)

- Thermal capacities flexibility features **2020 RES+**
 - More flexible capacities (retrofit of coal units, new generation of gas units...)

OPTIMATE parameters	Coal units <i>(for a nominal capacity of 300 MW)</i>		Gas units <i>(for a nominal capacity of 200 MW)</i>	
	Initial parameters	RES+ scenario parameters	Initial parameters	RES+ scenario parameters
Maximum Gradient (MW/h)	500	1,000	500	1,000
Minimum Duration (h)	2	1	0.5	0.25
Start-up Duration (h)	3.5	1.75	0	0

Description of the three scenarios (quantitative)

- Cross-border capacities 2013
 - Source: ENTSO-E transparency platform

from to	AT	BE	FR	DE	GB	IT n	IT s	NL	PT	ES	CH
AT				∞ ∞		116 82					1,196 1,189
BE			2,645 2,510					1,356 1,309			
FR		1,571 1,304		2,509 2,637	1,449 1,652	1,068 951				908 882	1,100 1,108
DE	∞ ∞		1,795 1,784					2,179 2,319			4,000 4,000
GB			1,449 1,664					1,005 958			
IT n	255 197		2,297 1,555				1,850 1,550				3,257 2,088
IT s						3,470 2,790					
NL		1,379 1,325		2,102 2,256	1,005 958						
PT										1,511 2,027	
ES			1,068 994						1,610 1,853		
CH	483 555		3,179 2,815	945 1,100		1,855 1,500					

Description of the three scenarios (quantitative)

- Cross-border capacities 2020 (standard and RES+)
- Source: TYNDP 2014

from to	AT	BE	FR	DE	GB	IT n	IT s	NL	PT	ES	CH
AT				∞ ∞		266 232					1,196 1,189
BE			2,645 2,510	<u>1,700</u> <u>1,700</u>	<u>1,000</u> <u>1,000</u>			2,606 2,559			
FR		1,571 1,304		2,509 2,637	4,449 4,652	2,068 1,951				4,008 3,982	1,300 1,308
DE	∞ ∞	<u>1,700</u> <u>1,700</u>	1,795 1,784					4,079 4,219			4,000 4,000
GB		<u>1,000</u> <u>1,000</u>	4,449 4,664					1,005 958		<u>1,000</u> <u>1,000</u>	
IT n	405 347		3,497 2,755				2,450 2,150				4,057 2,888
IT s						4,070 3,390					
NL		2,629 2,575		4,002 4,156	1,005 958						
PT										2,511 3,027	
ES			3,568 3,494		<u>1,000</u> <u>1,000</u>				2,010 2,253		
CH	483 555		3,679 3,415	945 1,126		2,655 2,336					

Description of the three scenarios (quantitative)

- Fuel and CO₂ prices
 - Sources 2013: EEX, ACER/CEER, IEA

	2013
CO ₂	4.38 €/t
Gas	28.26 €/MWh
Coal	61.67 €/t
Oil	109 \$/bbl

Description of the three scenarios (quantitative)

- Fuel and CO₂ prices
 - Sources 2013: EEX, ACER/CEER, IEA
 - Source 2020: EC Trends to 2050 Reference Scenario

	2013	2020 standard	<i>Evolution</i> 2020 / 2013
CO ₂	4.38 €/t	10 €/t	+128%
Gas	28.26 €/MWh	37.03 €/MWh	+31%
Coal	61.67 €/t	108.2 €/t	+75%
Oil	109 \$/bbl	115 \$/bbl	+6%

Description of the three scenarios (quantitative)

- Fuel and CO₂ prices
 - Sources 2013: EEX, ACER/CEER, IEA
 - Source 2020: EC Trends to 2050 Reference Scenario
 - Scenario 2020 RES+: CO₂ price allowing the coal-to-gas switch

	2013	2020 standard	Evolution 2020 / 2013	2020 RES+	Evolution RES+ / standard
CO ₂	4.38 €/t	10 €/t	+128%	40 €/t	+300%
Gas	28.26 €/MWh	37.03 €/MWh	+31%	37.03 €/MWh	+0%
Coal	61.67 €/t	108.2 €/t	+75%	108.2 €/t	+0%
Oil	109 \$/bbl	115 \$/bbl	+6%	115 \$/bbl	+0%



Outline

- Description of the three proposed scenarios
 - Summary of main features of each scenario (qualitative)
 - Common hypotheses to all scenarios
 - Description of the three scenarios (quantitative)
- **Combining the design options with the selected scenarios**
- Proposed parameters of the studied options



Combining the design options with the selected scenarios

Studies	Case #	Scenarios	RES SS	Demand flexibility
Default cases	1	2013	None	Low
	2	2020 standard	None	Low
	3	2020 RES+	None	Low
Study on RES support schemes				
Study on demand flexibility				

Combining the design options with the selected scenarios

Studies	Case #	Scenarios	RES SS	Demand flexibility
Default cases	1	2013	None	Low
	2	2020 standard	None	Low
	3	2020 RES+	None	Low
Study on RES support schemes	4	2013	Current RES SS (FiT and/or PP)	Low
Study on demand flexibility				

Combining the design options with the selected scenarios

Studies	Case #	Scenarios	RES SS	Demand flexibility
Default cases	1	2013	None	Low
	2	2020 standard	None	Low
	3	2020 RES+	None	Low
Study on RES support schemes	4	2013	Current RES SS (FiT and/or PP)	Low
	5	2020 standard	Current SS (FiT and/or PP) for old, PP for new units	Low
	6	2020 RES+	Current SS (FiT and/or PP) for old, PP for new units	Low
Study on demand flexibility				

Combining the design options with the selected scenarios

Studies	Case #	Scenarios	RES SS	Demand flexibility
Default cases	1	2013	None	Low
	2	2020 standard	None	Low
	3	2020 RES+	None	Low
Study on RES support schemes	4	2013	Current RES SS (FiT and/or PP)	Low
	5	2020 standard	Current SS (FiT and/or PP) for old, PP for new units	Low
	6	2020 RES+	Current SS (FiT and/or PP) for old, PP for new units	Low
Study on demand flexibility	7	2013	None	High
	8	2020 standard	None	High
	9	2020 RES+	None	High



Outline

- Market design options to be studied
- Indicators to assess the impacts of the studied options
- Proposed parameters of the studied options
 - **RES support schemes: wind and solar**
 - Demand flexibility



Parameters for the wind support schemes

- Current support schemes (2013)
 - Source: EWEA

	BE	FR	DE	IT	NL	ES	CH	PT	GB	AT
Percentage of wind generation sold under feed-in tariff	0%	100%	0%	100%	0%	100%	100%	100%	0%	100%
Wind Feed-in tariff average value (€/MWh)	-	82	-	122	-	81	146	74	-	94

Parameters for the wind support schemes

- Current support schemes (2013)
 - Source: EWEA

	BE	FR	DE	IT	NL	ES	CH	PT	GB	AT
Percentage of wind generation sold under feed-in tariff	0%	100%	0%	100%	0%	100%	100%	100%	0%	100%
Wind Feed-in tariff average value (€/MWh)	-	82	-	122	-	81	146	74	-	94
Percentage of wind generation sold under premium prices	100%	0%	100%	0%	100%	0%	0%	0%	100%	0%
Wind premium average price (€/MWh)	82	-	93	-	98	-	-	-	85	-

Parameters for the wind support schemes

- Envisaged support schemes for the **2020 standard scenario**

	BE	FR	DE	IT	NL	ES	CH	PT	GB	AT
Percentage of wind generation sold under feed-in tariff	0%	36%	0%	70%	0%	61%	5%	64%	0%	74%
Wind Feed-in tariff average value (€/MWh)	-	82	-	122	-	81	146	74	-	94

Parameters for the wind support schemes

- Envisaged support schemes for the **2020 standard scenario**

	BE	FR	DE	IT	NL	ES	CH	PT	GB	AT
Percentage of wind generation sold under feed-in tariff	0%	36%	0%	70%	0%	61%	5%	64%	0%	74%
Wind Feed-in tariff average value (€/MWh)	-	82	-	122	-	81	146	74	-	94
Percentage of wind generation sold under premium prices	100%	64%	100%	30%	100%	39%	95%	36%	100%	26%
Wind premium average price (€/MWh)	?	?	?	?	?	?	?	?	?	?

Parameters for the PV support schemes

- Current support schemes (2013)
 - Average values very complex to calculate (segmentation different in every country, support changes each year...)

	BE	FR	DE	IT	NL	ES	CH	PT	GB	AT
Percentage of PV generation sold under feed-in tariff	100%	100%	88%	100%	100%	100%	100%	100%	100%	100%
PV Feed-in tariff average value (€/MWh)	250	250	250	250	250	250	250	250	250	250

Parameters for the PV support schemes

- Current support schemes (2013)
 - Average values very complex to calculate (segmentation different in every country, support changes each year...)

	BE	FR	DE	IT	NL	ES	CH	PT	GB	AT
Percentage of PV generation sold under feed-in tariff	100%	100%	88%	100%	100%	100%	100%	100%	100%	100%
PV Feed-in tariff average value (€/MWh)	250	250	250	250	250	250	250	250	250	250
Percentage of PV generation sold under premium prices	0%	0%	12%	0%	0%	0%	0%	0%	0%	0%
PV premium average price (€/MWh)	-	-	107	-	-	-	-	-	-	-

Parameters for the PV support schemes

- Envisaged support schemes for the **2020 standard scenario**

	BE	FR	DE	IT	NL	ES	CH	PT	GB	AT
Percentage of PV generation sold under feed-in tariff	76%	43%	59%	72%	25%	44%	31%	23%	34%	30%
PV Feed-in tariff average value (€/MWh)	250	250	250	250	250	250	250	250	250	250
Percentage of PV generation sold under premium prices	24%	57%	41%	28%	75%	56%	69%	77%	66%	70%
PV premium average price (€/MWh)	?	?	?	?	?	?	?	?	?	?



Outline

- Market design options to be studied
- Indicators to assess the impacts of the studied options
- Proposed parameters of the studied options
 - RES support schemes: wind and solar
 - **Demand flexibility**





Parameters for demand flexibility

- Default case:
 - No demand flexibility
- Proposed parameters for voluntary load shedding:
 - Same parameters applied to all countries within the geographic scope considered
 - 5% of load would be shed when market prices reach **100€/MWh**





Co-funded by the Intelligent Energy Europe
Programme of the European Union

Thank you very much
for your attention